



**LAVORAZIONI MECCANICHE DI PRECISIONE
BROCCIATURA, STOZZATURA E GRATOMAT®**

**PRECISION MECHANICAL WORKING
BROACHING, SLOTTING AND GRATOMAT®**

**FEINMECHANIK-ARBEITE
RÄUMEN, STOSSEN UND GRATOMAT®**



LAVORAZIONI MECCANICHE DI PRECISIONE





FB SRL • UNA DELLE REALTÀ PIÙ ATTENTE DEL PANORAMA MANIFATTURIERO DEL SETTORE

La FB SRL nasce nel 1973 come piccola officina meccanica per conto terzi nella foratura e sbavatura degli ingranaggi. Dalla metà degli anni '90 la crescita della società è sostanziale sia in termini d'infrastruttura che di personale, macchinari e fatturato. Specializzata nella lavorazione di brocciatura (fino a d.350 mm), Stozzatura e Gratomat®, in piccole, medie e grandi serie con qualsiasi disegno o particolare a tabella, per soddisfare così una clientela sempre più ampia ed esigente.

FB SRL • MOST ATTENTIVE MECHANICAL ENGINEERING COMPANIES IN THE MANUFACTURING SECTOR

FB SRL was incorporated in 1973 as a small mechanical engineering concern performing contract work in the field of drilling and deburring of gears. From the mid 1990s the company grew significantly in terms of infrastructure, workforce, capital equipment and sales. Specialised in broaching (up to d.350 mm), slotting and deburring work in small, medium and large series to any specification or standardized parts to meet the needs of an increasingly extensive and demanding range of clients.

FB SRL • EINE FESTE GRÖSSE IM SEKTOR DER VERARBEITENDEN INDUSTRIE

Die FB SRL wurde 1973 als mittelständische, auf das Bohren und Entgraten von Zahnrädern spezialisierte Auftragswerkstatt gegründet. Die Firma verzeichnet ab Mitte der 90er Jahre ein stetiges Wachstum sowohl beim Ausbau der Infrastrukturen als auch bei Personal, Maschinen und Umsatz. Die FB SRL ist auf Anwendungen in den Bereichen Räumen (Bearbeitungsdurchmesser bis 350 mm) und Stoßen (und Entgraten mit Gratomat®), zur Realisierung von kleinen, mittleren und großen Stückzahlen nach unterschiedlichen Mustern oder Vorlagen spezialisiert, und in der Lage, eine breit gefächerte und anspruchsvolle Kundschaft zu bedienen.

LAVORAZIONI MECCANICHE DI PRECISIONE

Il continuo sviluppo aziendale ha fatto della **FB SRL** un partner affidabile e competitivo per i suoi clienti di fama mondiale.
I settori in cui opera maggiormente sono: costruttori di ingranaggi, riduttori, auto, movimento terra, motociclo.

Relentless development of the business has made **FB SRL** a reliable and competitive partner for several internationally renowned customers.
The main client sectors include gear makers, mechanical drive manufacturers and companies active in the automotive, earthmoving machinery and motorcycles sectors.

Die kontinuierliche Weiterentwicklung hat **FB SRL** zu einem zuverlässigen und wettbewerbsfähigen Partner für viele prestigeträchtige Kunden gemacht.
Die wichtigsten Zielbranchen des Unternehmens sind:
Zahnräder-und Getriebeherstellung, Automobilsektor, Erdbewegung, Motorradsektor.

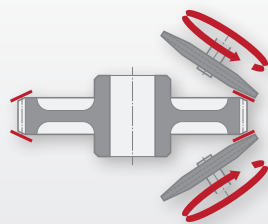

GRATOMAT®

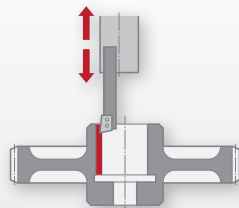

STOZZATURA
SLOTING
STOSSEN

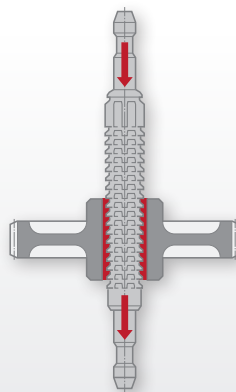

BROCCIATURA
BROACHING
RÄUMEN





BROCCIATURA

Nel corso degli anni la **FB SRL** si è specializzata nella lavorazione di brocciatura per conto terzi. Ad oggi conta 18 macchine di ultima generazione di cui la metà automatizzate e può arrivare a lavorare corone epicicloidali fino a 350 mm di diametro.

BROACHING

Over the years **FB SRL** has specialised in broaching work under contract. The company currently has 18 broaching machines of the latest generation, half of which automatic, and it can produce planetary ring gears with diameters of up to 350 mm.

RÄUMEN

Im Laufe der Jahre hat **FB SRL** sich auf Räumbearbeitungen im Auftrag Dritter spezialisiert. Der Maschinenbestand zählt derzeit 18 Maschinen der jüngsten Generation, von denen die Hälfte automatisiert ist. Es können beispielsweise Hohlräder für Planetengetriebe mit bis zu 350 mm Durchmesser bearbeitet werden.

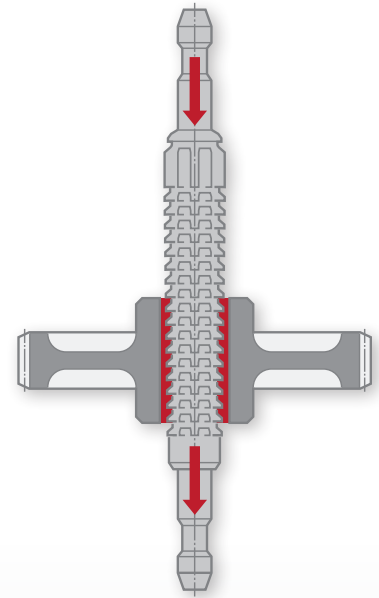

BROCCIATURA BROACHING RÄUMEN



LAVORAZIONI MECCANICHE DI PRECISIONE

STOZZATURA

La **FB SRL** ha la possibilità di eseguire cave a C.N. nei fori ciechi o passanti per piccole, medie e grandi serie.

SLOTING

FB SRL can perform NC machining of keyways in stopped or thru-holes for small, medium, and large series production.

STOSSEN

Die **FB SRL** ist in der Lage, mittels NC-Formfräsen Nuten in Blind- und Durchgangsbohrungen für kleine, mittlere und große Stückzahlen herzustellen.

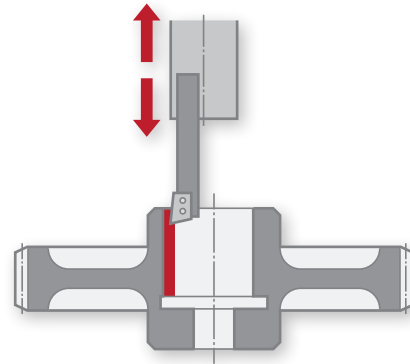

STOZZATURA SLOTING STOSSEN





GRATOMAT®

L'operazione di sbavatura oggi è diventata sempre più importante per la riduzione della rumorosità degli ingranaggi. Ad oggi la **FB SRL** conta 10 macchine di sbavatura di cui una automatizzata.

GRATOMAT®

Deburring procedures are increasingly in demand due to their ability to reduce running noise of gear trains. **FB SRL** currently has 10 deburring machines, one of which automatic.

GRATOMAT®

Das Entgraten ist ein zunehmend wichtiger Prozess zur Reduzierung von Getriebegeräuschen. **FB SRL** verfügt derzeit über 10 Entgratungsmaschinen, darunter eine automatisierte Maschine.

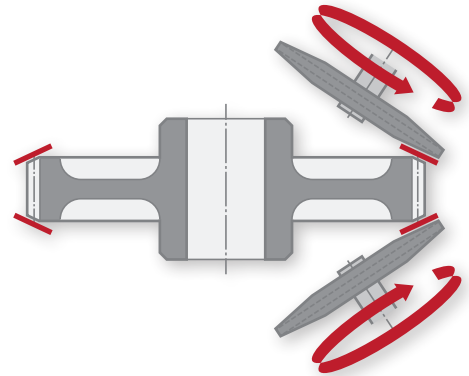

GRATOMAT®



LAVORAZIONI MECCANICHE DI PRECISIONE

Il conseguimento del certificato ISO 9001, il continuo sviluppo di macchinari, nuovi investimenti produttivi, il personale altamente specializzato e strumenti di misura di ultima generazione hanno permesso all'azienda di entrare a far parte dei principali costruttori di trasmissioni meccaniche in genere.

Gaining of ISO 9001 certification, constant development of machinery, new investments in the production process, highly skilled personnel and the latest generation of measuring instruments have allowed the company to enter the ranks of the leading manufacturers of mechanical transmissions. FB SRL is constantly evolving in terms of technology and continual research in the drive to improve production efficiency and maximise quality levels.

Die Zertifizierung nach ISO 9001, die kontinuierliche Entwicklung neuer Maschinen, Anlageinvestitionen, hochqualifizierten Mitarbeiter und Messgeräte der neuesten Generation stellen die Voraussetzungen dafür dar, dass die Firma heute zu einem führenden Hersteller von mechanischen Getrieben aufgestiegen ist. FB SRL ist ein dynamisches Unternehmen, das dem kontinuierlichen technologischen Fortschritt verpflichtet ist und eine stetige Verbesserung der Herstellungs- und Qualitätssicherungsprozesse anstrebt.



REPARTO PRODUZIONE

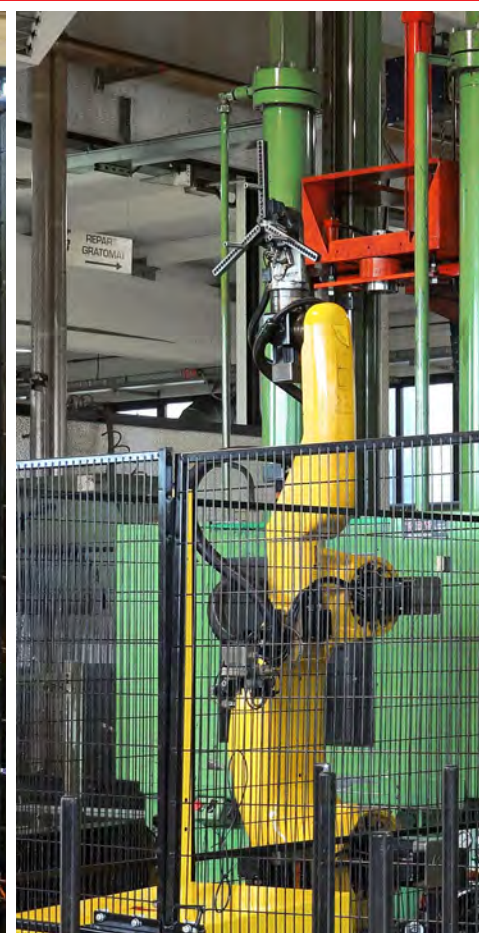
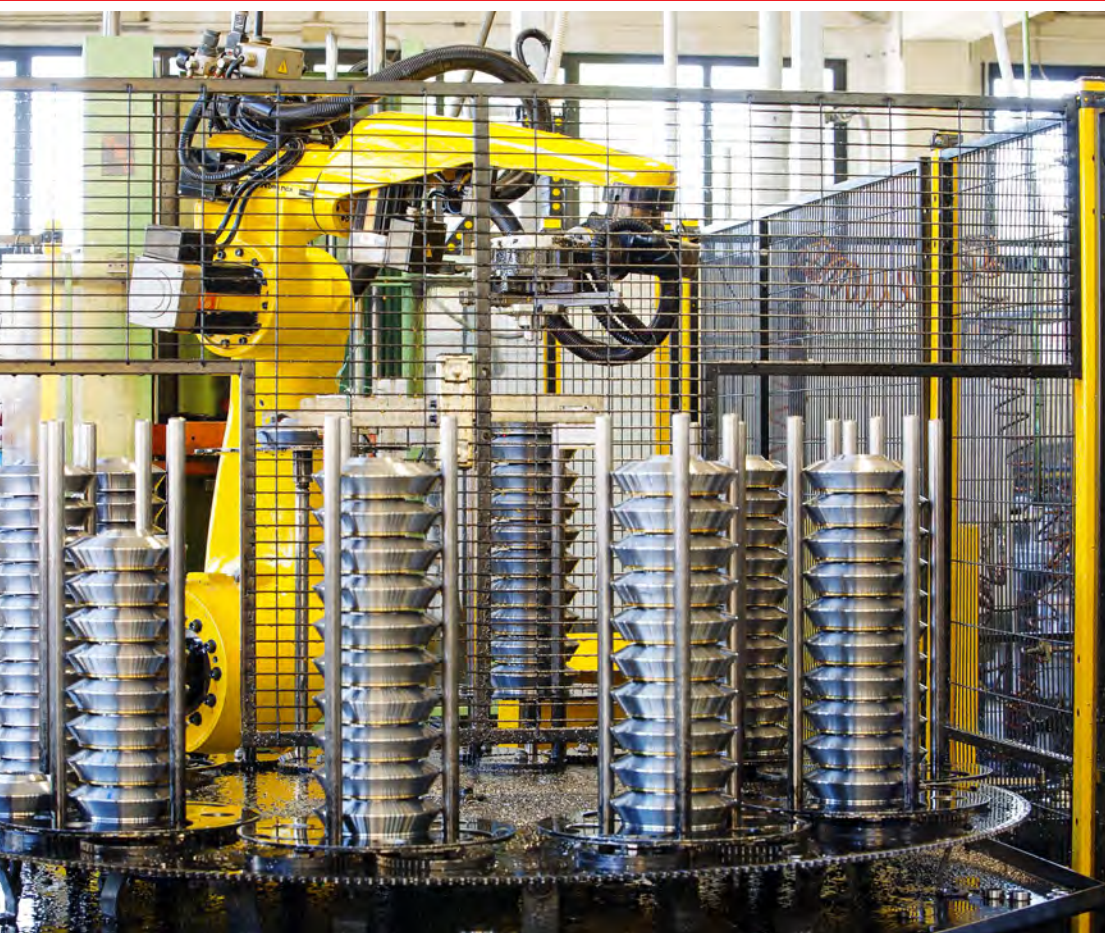



la **FB SRL** ha fatto da sempre della qualità e dell'affidabilità i suoi obiettivi principali e grazie alla costante attenzione rivolta agli sviluppi e alle tendenze del settore, riveste oggi un ruolo di primo piano nell'industria manifatturiera in Italia, anche per efficienza e tempi di risposta.

FB SRL has always made quality and reliability its core aims and thanks to the constant attention to developments and trends in the sector the company currently occupies a front line position in the manufacturing industry in Italy, also in terms of efficiency and turnaround times.

Dank des rigorosen Qualitätsmanagements und Gespürs für die jeweils aktuellen Entwicklungen und Trends in der Branche spielt **FB SRL** heute eine führende Rolle in der verarbeitenden Industrie in Italien und ist in der Lage, Aufträge effizient und in kürzest möglicher Zeit abzuwickeln.

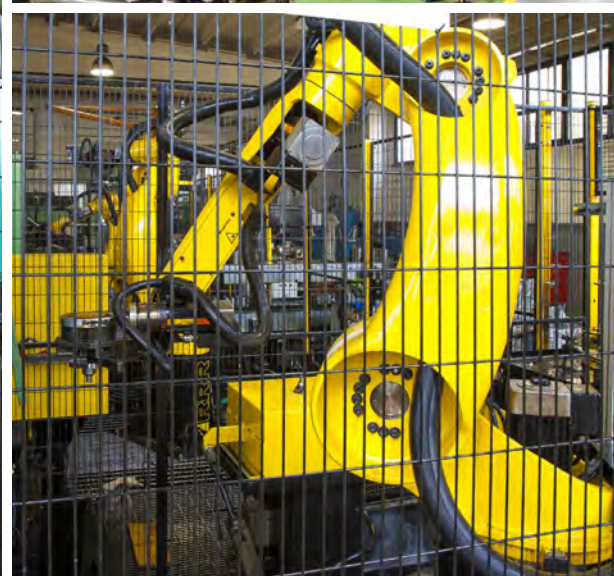
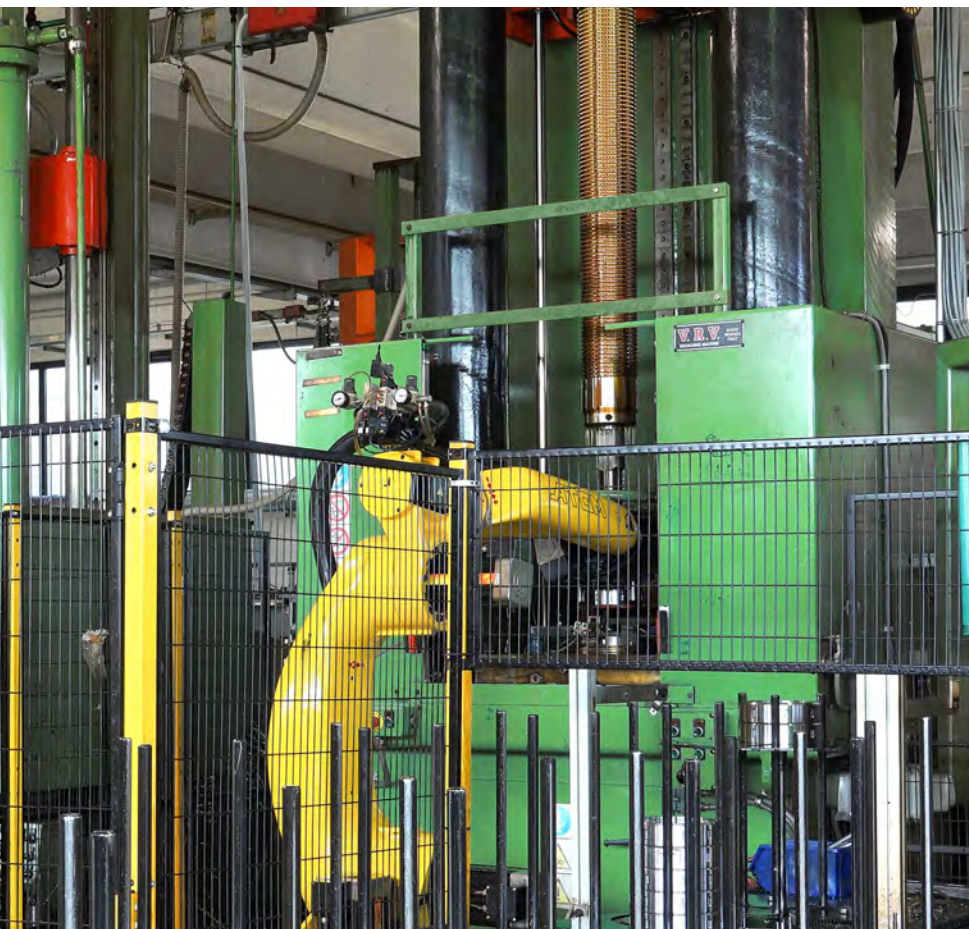

LAVORAZIONI MECCANICHE DI PRECISIONE



• **18** Impianti di Brocciatura
Broaching Equipment
Räumpflanzen

• **46** Anni di attività
Years of activity
Jahre der Tätigkeit

• **8** Robot con magazzino di caricamento automatico
Robot with automatic loading warehouse
Roboter mit automatischem Lademagazin

• **2** Impianti di Stozzatura
Slotting Equipment
Stossen maschinen

• **10** Impianti GRATOMAT®
GRATOMAT® Equipment
GRATOMAT® Ausrüstung

• **1^A** Qualità nelle lavorazioni
Quality in processing
Qualität in der Verarbeitung

MACCHINE UTENSILI FB SRL



CAMS
Stozzatrice
corsa 300 mm
4 assi CNC

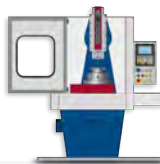

CAMS
Stozzatrice
corsa 200 mm
3 assi CNC

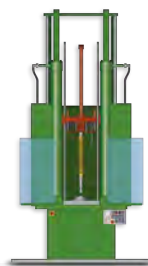

VRV
Brocciatrice
15 Ton
corsa 1600 mm
con guida broccia

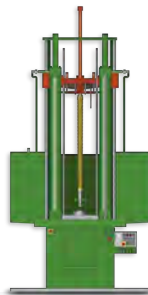

VRV
Brocciatrice
25 Ton
corsa 1800 mm
con guida broccia

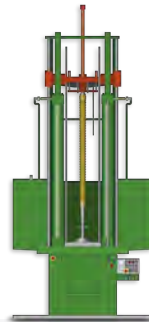

VRV
Brocciatrice
25 Ton
corsa 1800 mm
con guida broccia

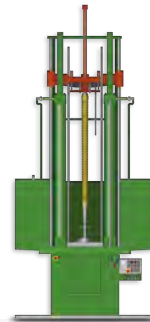

VRV
Brocciatrice
25 Ton
corsa 1800 mm
con guida broccia



VRV
Brocciatrice
15 Ton
corsa 1200 mm
con guida broccia

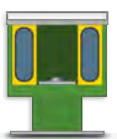

MINI TOOLS
Gratomat®

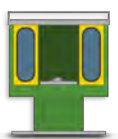

MINI TOOLS
Gratomat®



RASCH
Gratomat®



MPM
Gratomat®



MPM
Gratomat®



MPM
Gratomat®



MPM
Gratomat®



MPM
Gratomat®

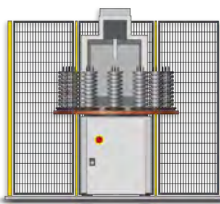

TECNOMACCHINE
Automatizzata
Gratomat®

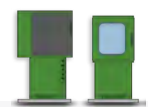

MAGNAGHI
Brocciatrice
10 Ton
1400 mm



VARINELLI
Brocciatrice
10 Ton
800 mm



• **350 mm** Diametro massimo degli utensili da Brocciatura
Maximum diameter of broaching tools
Maximaler Durchmesser der Räumwerkzeuge

• **2800 mm** Lunghezza massima degli utensili da Brocciatura
Maximum length of broaching tools
Maximale Länge der Räumwerkzeuge

• **600** Utensili tabella a norma DIN 5480 - 5482 5481 Profilo UNI-SAE
Tools according to DIN 5480 - 5482 5481 UNI-SAE profile
Werkzeuge nach DIN 5480 - 5482 5481 UNI-SAE Profil

• **2** Controlli automatizzati ZEISS avanzati
Advanced ZEISS automated measuring systems
Fortschrittliche automatisierte ZEISS Steuerungen

• **H15/5** Ciclo continuo di lavoro degli impianti di Produzione
Continuous work cycle of production plants
Kontinuierlicher Arbeitszyklus von Produktionsanlagen

• **4/5 giorni** Tempo medio di consegna delle commesse di lavoro
Average delivery time for work orders
Durchschnittliche Lieferzeit für Arbeitsaufträge

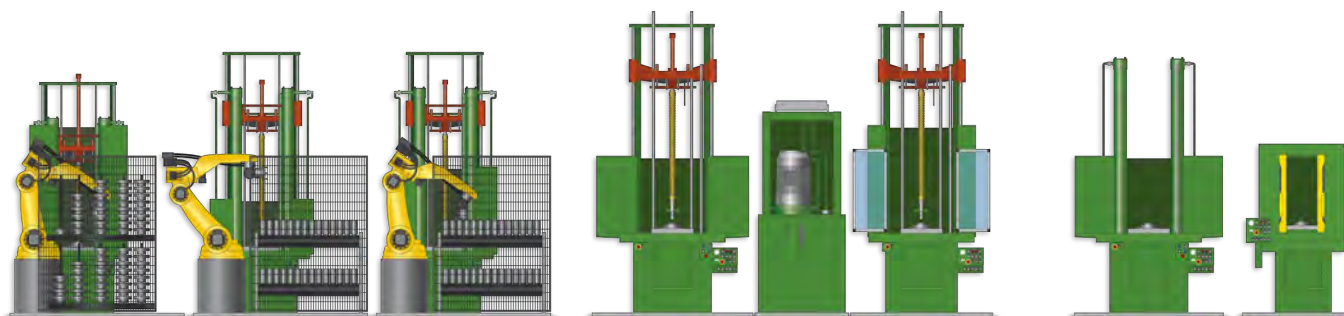

VRV
Brocciatrice
Automatizzata
15 Ton
corsa 1200 mm
con guida broccia

VRV
Brocciatrice
Automatizzata
25 Ton
corsa 1800 mm
con guida broccia

VRV
Brocciatrice
Automatizzata
16 Ton
corsa 1600 mm
con guida broccia

VRV
Brocciatrice
25 Ton
corsa 1800 mm
con guida broccia

VRV
Brocciatrice
25 Ton
corsa 1800 mm
con guida broccia

VRV
Brocciatrice
10 Ton
corsa 1400 mm
con guida broccia

VARINELLI
Brocciatrice
meccanica
corsa 1400 mm

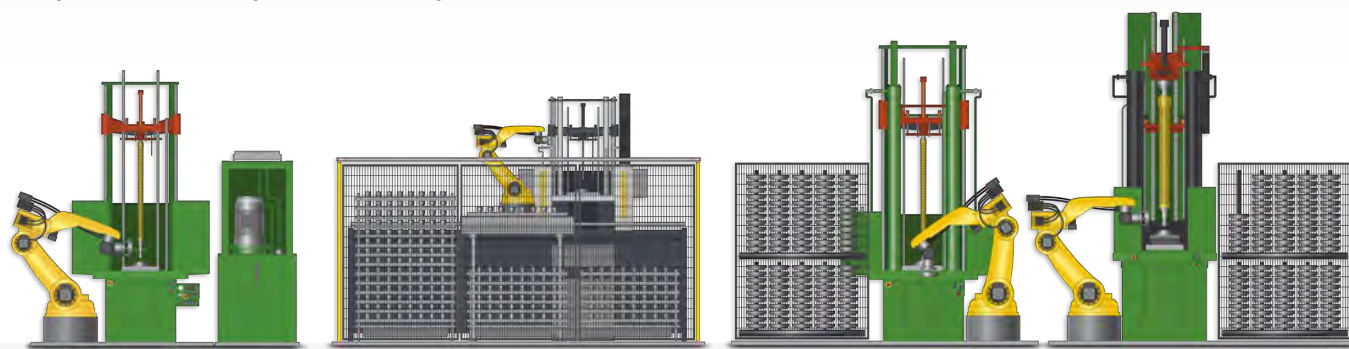

VRV
Brocciatrice
Automatizzata
15 Ton
corsa 1800 mm
con guida broccia

ARPINI
Brocciatrice
Automatizzata
10 Ton
corsa 1000 mm
con guida broccia

VRV
Brocciatrice
Automatizzata
50 Ton
corsa 2500 mm
con guida broccia

VRV
Brocciatrice
Automatizzata
70 Ton
corsa 2750 mm
con guida broccia

LAVORAZIONI MECCANICHE DI PRECISIONE

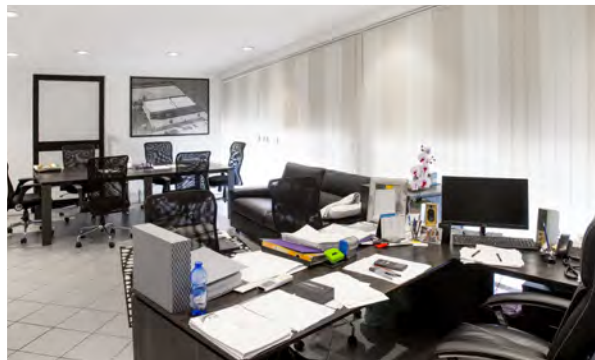

LABORATORIO CONTROLLO QUALITÀ

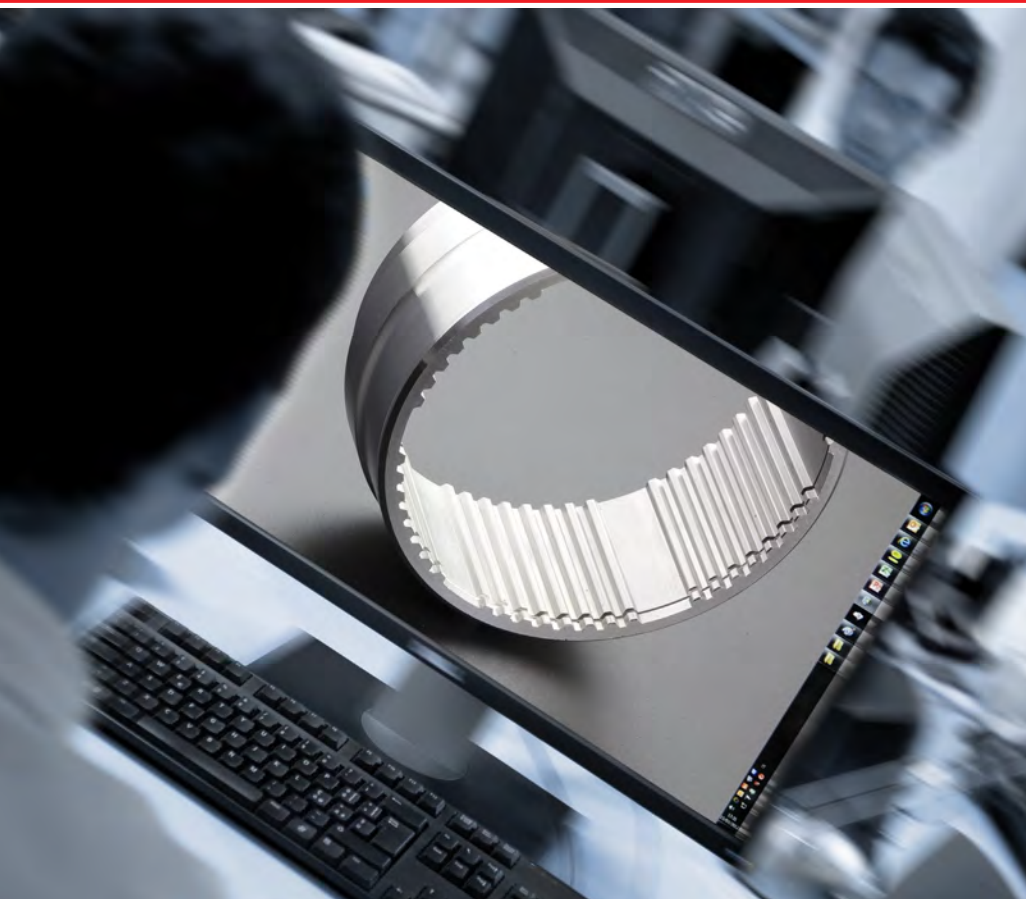



Qualità, competenza, tecnologia e servizio fanno la differenza sul mercato globale e queste caratteristiche ben presenti in FB SRL le consentono di essere un partner affidabile per i propri clienti. La nostra produzione è costantemente controllata da 2 sistemi automatizzati ZEISS che operano in sala metrologica climatizzata.

Quality, competence, technology and service are decisive factors on the global market and since FB SRL achieves excellence in all these areas the company is well placed to act as a reliable partner for its customers. Our production is constantly controlled by 2 ZEISS automated systems operating in air-conditioned metrology room.

Qualität, Kompetenz, Technologie und Service sind die Eigenschaften, die gefordert sind, um sich am Weltmarkt zu behaupten und die FB SRL zu einem zuverlässigen Geschäftspartner machen. Unsere Produktion wird ständig von kontrolliert 2 ZEISS Automationsysteme im klimatisierten Messraum.



LAVORAZIONI MECCANICHE DI PRECISIONE

SETTORI DI APPLICAZIONE:

Autoveicoli,
Motoveicoli,
Macchine movimento terra,
Veicoli da trasporto leggero e pesante,
Componenti navali,
Macchine agricole,
Trattori,
Muletti e sistemi di sollevamento,
Cambi e Differenziali,
Riduttori e Motoriduttori,
Pompe ad alta pressione,
Compressori,
Gruppi elettrogeni,
Macchine utensili,
Macchine industriali,
Macchine per stampa,
Componenti per automazione,
Macchine industria alimentare,
Sistemi di precisione,
Macchine tessili,
Elettromedicali,
Motori sportivi,
Go-Kart,
Componenti per competizioni,
Aeronautica.

APPLICATION FIELDS:

Vehicles,
Motorcycles,
Earth moving machines,
Light and heavy transport vehicles
Naval components,
Agricultural machinery,
Tractors,
Forklifts and lifting systems,
Exchange rates and Differentials
Gearboxes and Gearmotors
High pressure pumps,
Compressors,
Generating sets,
Machine tools,
Industrial machines,
Printing machines,
Automation components,
Food industry machines,
Precision Systems,
Textile machines,
Electromedical,
Sports Engines,
Go-Kart,
Components for competitions,
Aviation.

ANWENDUNGSBEREICHE:

Fahrzeuge,
Motorräder,
Erdbewegungsmaschinen,
Leichte und schwere Transportfahrzeuge
Schiffskomponenten,
Landwirtschaftliche Maschinen,
Traktoren,
Gabelstapler und Hebesysteme,
Wechselkurse und Differentiale
Getriebe und Getriebemotoren
Hochdruckpumpen,
Kompressoren,
Generieren von Sets,
Werkzeugmaschinen,
Industriemaschinen,
Druckmaschinen,
Automatisierungskomponenten,
Maschinen für die Lebensmittelindustrie,
Präzisionssysteme,
Textilmaschinen,
Elektrotherapie ,
Sportmotoren,
Go-Kart,
Komponenten für Wettbewerbe,
Luftfahrt.

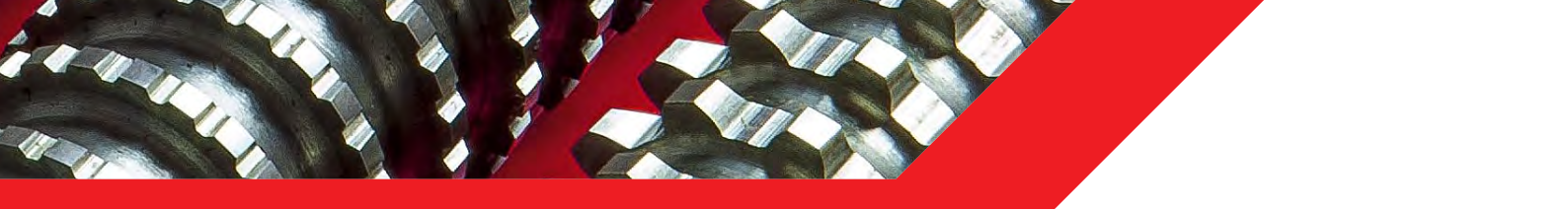

LAVORAZIONI MECCANICHE DI PRECISIONE

BROCCIATURA, STOZZATURA E GRATOMAT®





Via Artigianato, 605
40014 Crevalcore Bologna - Italy
Ph: +39 051 981928
info@fb-srl.com
www.fb-srl.com